



# **USER MANUAL**

**DN-170040/ DN-170041**

**Online UPS**

Uninterruptible Power Supply System

**Version:1.0**

# Table of Contents

1. Important Safety Warning.....	1
1-1. Transportation .....	1
1-2. Preparation.....	1
1-3. Installation .....	1
1-4. Operation .....	1
1-5. Maintenance, service and faults.....	2
2. Installation and setup.....	3
2-1 Rear panel view .....	3
2-2. Install the UPS.....	4
2-3. Setup the UPS .....	4
2-4 Battery Replacement .....	6
2-5 Battery Kit Assembly (option) .....	7
3. Operations .....	10
3-1. Button operation .....	10
3-2. LCD Panel.....	11
3-3. Audible Alarm .....	12
3-4. LCD display wordings index.....	12
3-5. UPS Setting .....	13
3-6. Operating Mode Description .....	16
3-7. Faults Reference Code .....	16
3-8. Warning indicator .....	17
4. Troubleshooting .....	18
5. Storage and Maintenance .....	20
6. Specifications .....	21

# 1. Important Safety Warning

Please comply with all warnings and operating instructions in this manual strictly. Save this manual properly and read carefully the following instructions before installing the unit. Do not operate this unit before reading through all safety information and operating instructions carefully

## 1-1. Transportation

- Please transport the UPS system only in the original package to protect against shock and impact.

## 1-2. Preparation

- Condensation may occur if the UPS system is moved directly from cold to warm environment. The UPS system must be absolutely dry before being installed. Please allow at least two hours for the UPS system to acclimate the environment.
- Do not install the UPS system near water or in moist environments.
- Do not install the UPS system where it would be exposed to direct sunlight or near heater.
- Do not block ventilation holes in the UPS housing.

## 1-3. Installation

- Do not connect appliances or devices which would overload the UPS system (e.g. laser printers) to the UPS output sockets.
- Place cables in such a way that no one can step on or trip over them.
- Do not connect domestic appliances such as hair dryers to UPS output sockets.
- The UPS can be operated by any individuals with no previous experience.
- Connect the UPS system only to an earthed shockproof outlet which must be easily accessible and close to the UPS system.
- Please use only VDE-tested, CE-marked mains cable (e.g. the mains cable of your computer) to connect the UPS system to the building wiring outlet (shockproof outlet).
- Please use only VDE-tested, CE-marked power cables to connect the loads to the UPS system.
- When installing the equipment, it should ensure that the sum of the leakage current of the UPS and the connected devices does not exceed 3.5mA.

## 1-4. Operation

- Do not disconnect the mains cable on the UPS system or the building wiring outlet (shockproof socket outlet) during operations since this would cancel the protective earth of the UPS system and of all connected loads.
- The UPS system features its own, internal current source (batteries). The UPS output sockets or output terminals block may be electrically live even if the UPS system is not connected to the building wiring outlet.
- In order to fully disconnect the UPS system, first press the OFF/Enter button to disconnect the mains.
- Prevent no fluids or other foreign objects from inside of the UPS system.

## 1-5. Maintenance, service and faults

- The UPS system operates with hazardous voltages. Repairs may be carried out only by qualified maintenance personnel.
- **Caution** - risk of electric shock. Even after the unit is disconnected from the mains (building wiring outlet), components inside the UPS system are still connected to the battery and electrically live and dangerous.
- Before carrying out any kind of service and/or maintenance, disconnect the batteries and verify that no current is present and no hazardous voltage exists in the terminals of high capability capacitor such as BUS-capacitors.
- Only persons are adequately familiar with batteries and with the required precautionary measures may replace batteries and supervise operations. Unauthorized persons must be kept well away from the batteries.
- **Caution** - risk of electric shock. The battery circuit is not isolated from the input voltage. Hazardous voltages may occur between the battery terminals and the ground. Before touching, please verify that no voltage is present!
- Batteries may cause electric shock and have a high short-circuit current. Please take the precautionary measures specified below and any other measures necessary when working with batteries:
  - remove wristwatches, rings and other metal objects
  - use only tools with insulated grips and handles.
- When changing batteries, install the same number and same type of batteries.
- Do not attempt to dispose of batteries by burning them. This could cause battery explosion.
- Do not open or destroy batteries. Escaping electrolyte can cause injury to the skin and eyes. It may be toxic.
- Please replace the fuse only with the same type and amperage in order to avoid fire hazards.
- Do not dismantle the UPS system.

## 2. Installation and setup

**NOTE:** Before installation, please inspect the unit. Be sure that nothing inside the package is damaged. Please keep the original package in a safe place for future use.

**NOTE:** There are two different types of online UPS: standard and long-run models. Please refer to the following model table.

Model No.	Type	Model No.	Type
DN-170040	Standard	DN-170040L	Long-run
DN-170041		DN-170041L	

### 2-1 Rear panel view

**1K/1.5K IEC**

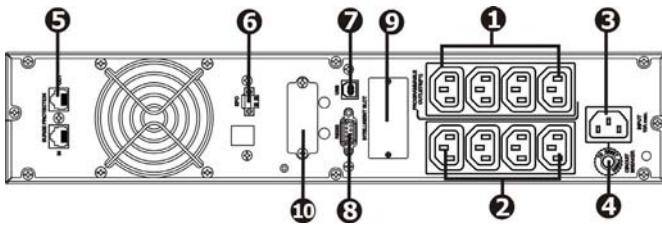

**2K IEC**

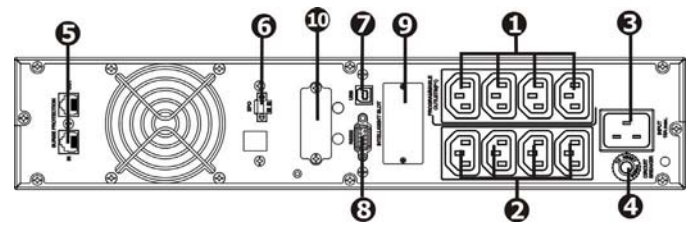

**3K IEC**

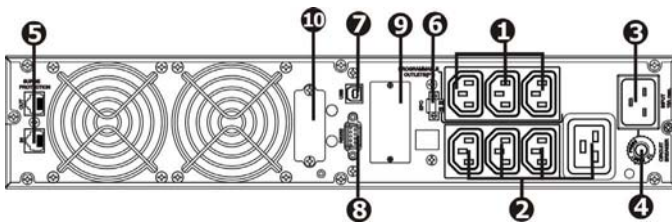

1. Programmable outlets: connect to non-critical loads.
2. Output receptacles: connect to mission-critical loads.
3. AC input
4. Input circuit breaker
5. Network/Fax/Modem surge protection
6. Emergency power off function connector (EPO)
7. USB communication port
8. RS-232 communication port
9. SNMP intelligent slot
10. External battery connector (only available for long-run models)

## 2-2. Install the UPS

For safety consideration, the UPS is shipped out from factory without connecting battery wires. Before install the UPS, please follow below steps to re-connect battery wires first.

### Step 1

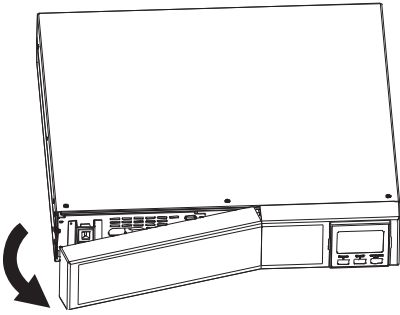

Remove front panel.

### Step 2

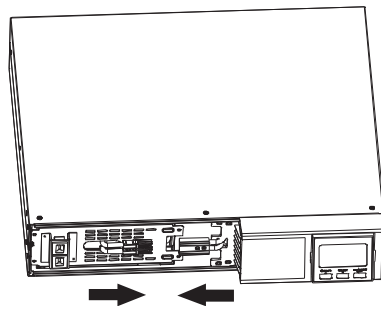

Connect the AC input and re-connect battery wires.

### Step 3

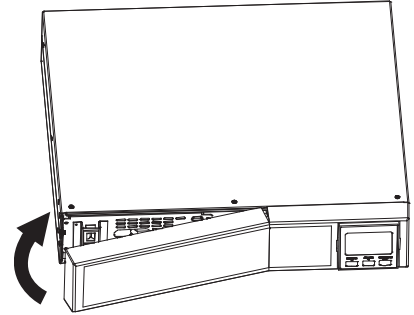

Put the front panel back to the unit.

This UPS can be either displayed on the desk or mounted in the 19" rack chassis. Please choose proper installation to position this UPS.

## Rack-mount Installation

### Step 1

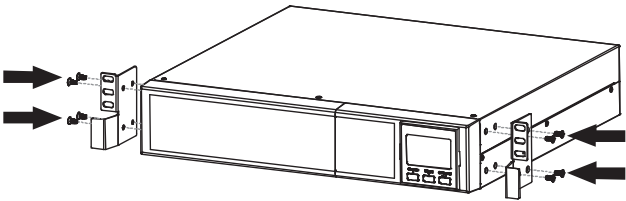

### Step 2

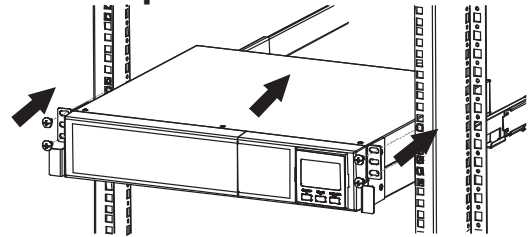

## Tower Installation

### Step 1

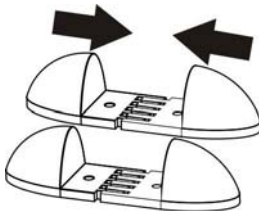

### Step 2

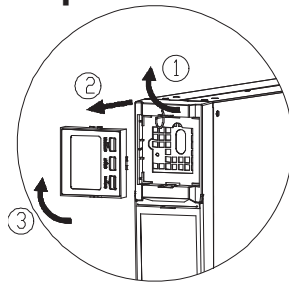

### Step 3

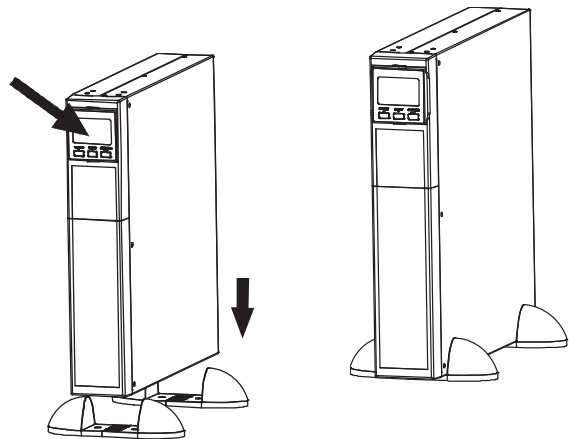

## 2-3. Setup the UPS

### Step 1: UPS input connection

Plug the UPS into a two-pole, three-wire, grounded receptacle only. Avoid using extension cords.

## Step 2: UPS output connection

For socket-type outputs, there two kinds of outputs: programmable outlets and general outlets. Please connect non-critical devices to the programmable outlets and critical devices to the general outlets. During power failure, you may extend the backup time to critical devices by setting shorter backup time for non-critical devices.

## Step 3: Communication connection

### Communication port:

#### USB port



#### RS-232 port

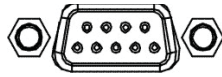

#### Intelligent slot



To allow for unattended UPS shutdown/start-up and status monitoring, connect the communication cable one end to the USB/RS-232 port and the other to the communication port of your PC. With the monitoring software installed, you can schedule UPS shutdown/start-up and monitor UPS status through PC.

The UPS is equipped with intelligent slot perfect for either SNMP or AS400 card. When installing either SNMP or AS400 card in the UPS, it will provide advanced communication and monitoring options.

**PS. USB port and RS-232 port can't work at the same time.**

## Step 4: Network connection

### Network/Fax/Phone surge port



Connect a single modem/phone/fax line into surge-protected "IN" outlet on the back panel of the UPS unit. Connect from "OUT" outlet to the equipment with another modem/fax/phone line cable.

## Step 5: Disable and enable EPO function

Keep the pin 1 and pin 2 closed for UPS normal operation. To activate EPO function, cut the wire between pin 1 and pin 2.

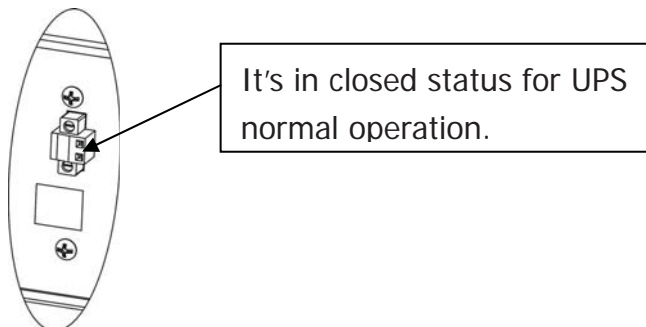

## Step 6: Turn on the UPS

Press the ON/Mute button on the front panel for two seconds to power on the UPS.

Note: The battery charges fully during the first five hours of normal operation. Do not expect full battery run capability during this initial charge period.

## Step 7: Install software

For optimal computer system protection, install UPS monitoring software to fully configure UPS shutdown. Please follow steps below to download and install monitoring software:

1. Go to the website <http://www.power-software-download.com>
2. Click ViewPower software icon and then choose your required OS to download the software.
3. Follow the on-screen instructions to install the software.
4. When your computer restarts, the monitoring software will appear as an orange plug icon located in the system tray, near the clock.

## 2-4 Battery Replacement

**NOTICE:** This UPS is equipped with internal batteries and user can replace the batteries without shutting down the UPS or connected loads. (hot-swappable battery design) Replacement is a safe procedure, isolated from electrical hazards.

**CAUTION!!** Consider all warnings, cautions, and notes before replacing batteries.

**Note:** Upon battery disconnection, equipment is not protected from power outages.

### Step 1

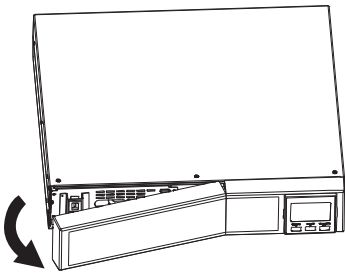

Remove front panel.

### Step 2

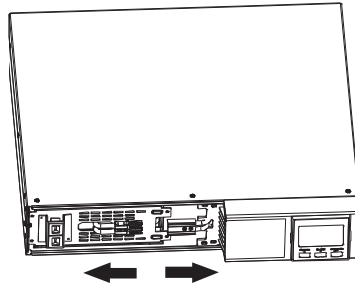

Disconnect battery wires.

### Step 3

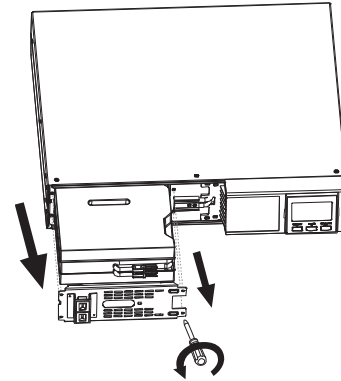

Pull out the battery box by removing two screws on the front panel.

### Step 4

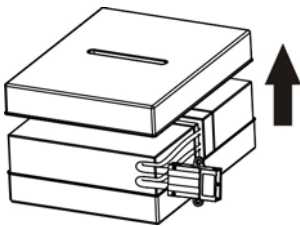

Remove the top cover of battery box and replace the inside batteries.

### Step 5

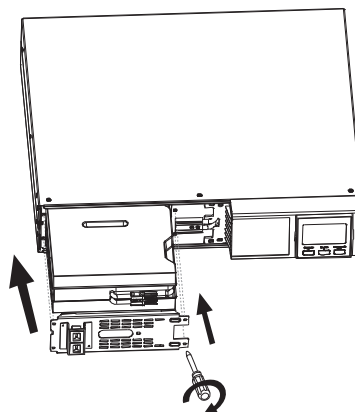

After replacing the batteries, put the battery box back to original location and screw it tightly.

### Step 6

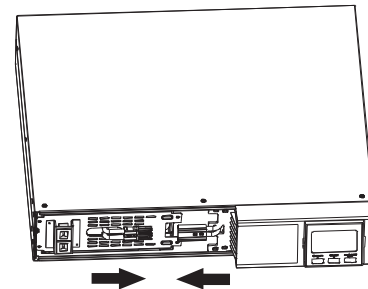

Re-connect the battery wires.



## Step 7

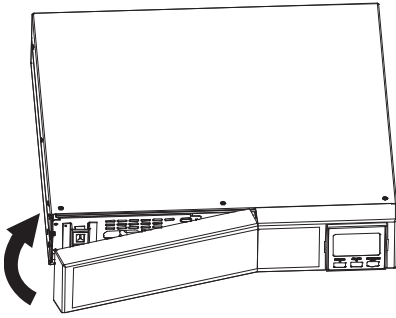

Put the front panel back to the unit.

## 2-5 Battery Kit Assembly (option)

**NOTICE:** Please assemble battery kit first before installing it inside of UPS. Please select correct battery kit procedure below to assemble it.

### 2-battery kit

Step 1: Remove adhesive tapes.

Tapes

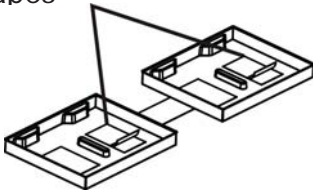

Step 3: Put assembled battery packs on one side of plastic shells.

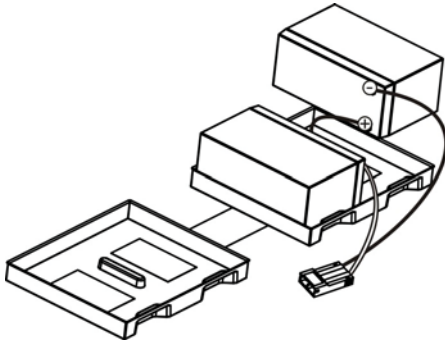

Step 2: Connect all battery terminals by following below chart.

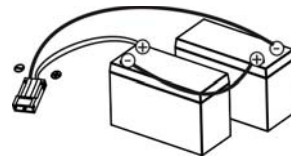

Step 4: Cover the other side of plastic shell as below chart. Then, battery kit is assembly well.

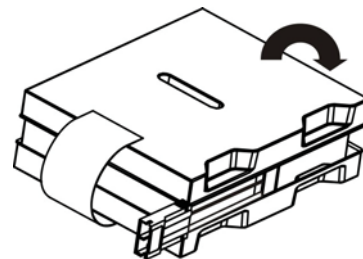

### 3-battery kit

Step 1: Remove adhesive tapes.

Tapes

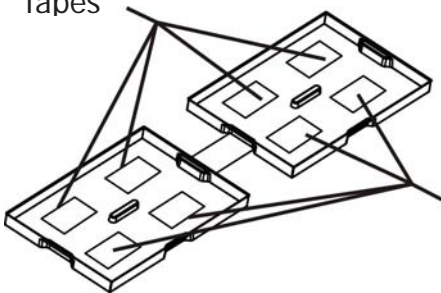

Tapes

Step 2: Connect all battery terminals by following below chart.

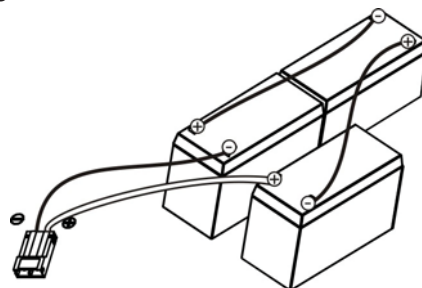

Step 3: Put assembled battery packs on one side of plastic shells and insert one more defect battery on the space.

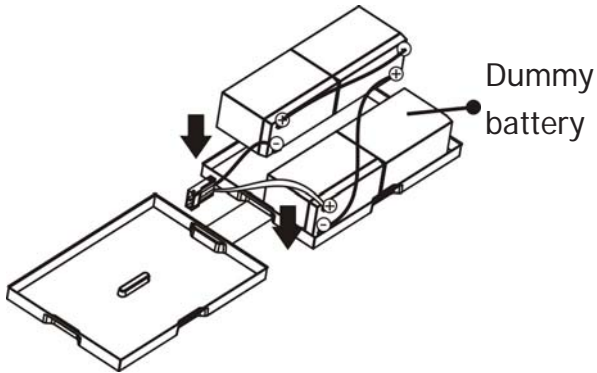

Step 4: Cover the other side of plastic shell as below chart. Then, battery kit is assembly well.

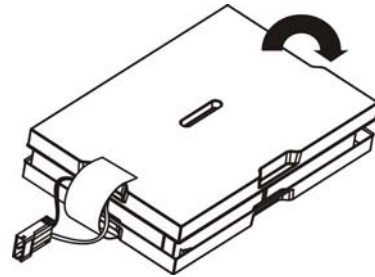

**4-battery kit**

Step 1: Remove adhesive tapes.

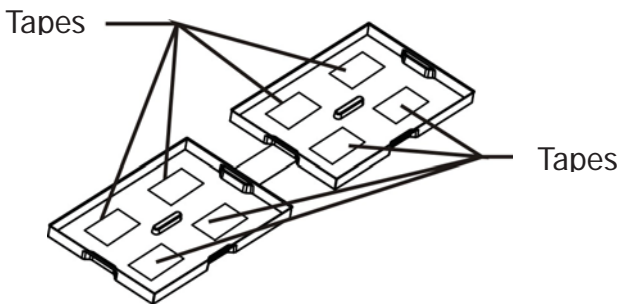

Step 2: Connect all battery terminals by following below chart.

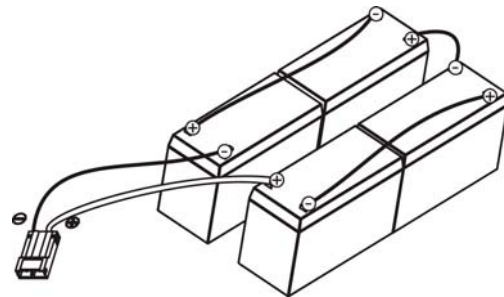

Step 3: Put assembled battery packs on one side of plastic shells.

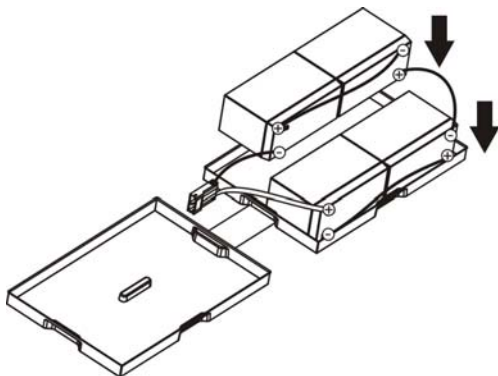

Step 4: Cover the other side of plastic shell as below chart. Then, battery kit is assembly well.

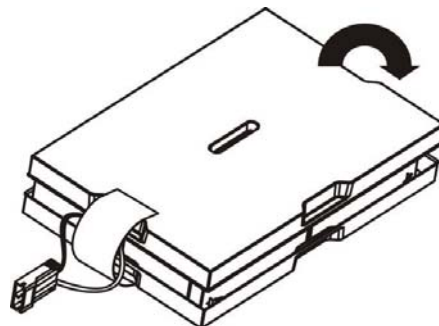

## 6-battery kit

Step 1: Remove adhesive tapes.

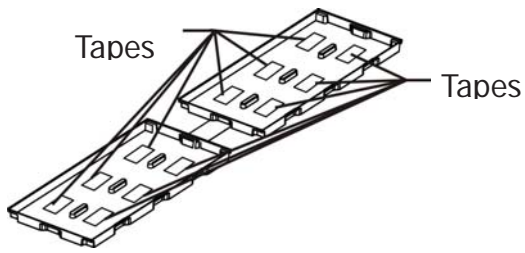

Step 2: Connect all battery terminals by following below chart.

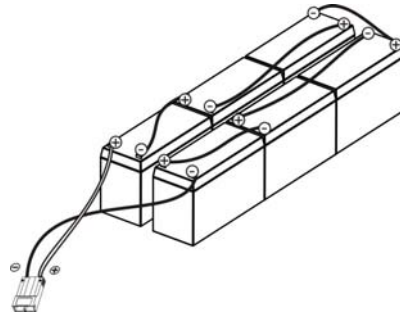

Step 3: Put assembled battery packs on one side of plastic shells.

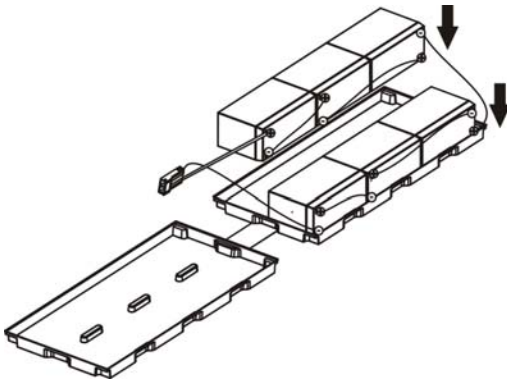

Step 4: Cover the other side of plastic shell as below chart. Then, battery kit is assembly well.

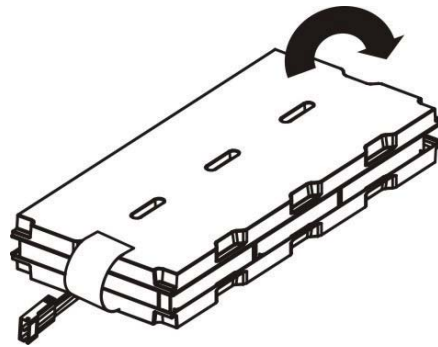

## 3. Operations

### 3-1. Button operation





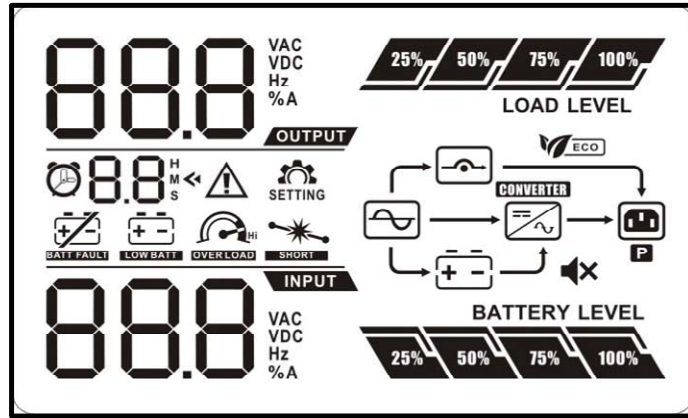

**Button View**

Button	Function
ON/Mute Button	<ul style="list-style-type: none"> <li>➤ Turn on the UPS: Press and hold ON/Mute button for at least 2 seconds to turn on the UPS.</li> <li>➤ Mute the alarm: After the UPS is turned on in battery mode, press and hold this button for at least 5 seconds to disable or enable the alarm system. But it's not applied to the situations when warnings or errors occur.</li> <li>➤ Up key: Press this button to display previous selection in UPS setting mode.</li> <li>➤ Switch to UPS self-test mode: Press ON/Mute buttons simultaneously for 5 seconds to enter UPS self-testing while in AC mode, ECO mode, AECO mode, or converter mode.</li> </ul>
OFF/Enter Button	<ul style="list-style-type: none"> <li>➤ Turn off the UPS: Press and hold this button at least 2 seconds to turn off the UPS in battery mode. UPS will be in standby mode under power normal or transfer to bypass mode if the Bypass enable setting by pressing this button.</li> <li>➤ Confirm selection key: Press this button to confirm selection in UPS setting mode.</li> </ul>
Select Button	<ul style="list-style-type: none"> <li>➤ Switch LCD message: Press this button to change the LCD message for input voltage, input frequency, battery voltage, output voltage, output frequency.</li> <li>➤ Setting mode: Press and hold this button for 5 seconds to enter UPS setting mode when Standby and Bypass mode.</li> <li>➤ Down key: Press this button to display next selection in UPS setting mode.</li> </ul>
ON/Mute + Select Button	<ul style="list-style-type: none"> <li>➤ Switch to bypass mode: When the main power is normal, press ON/Mute and Select buttons simultaneously for 5 seconds. Then UPS will enter to bypass mode. This action will be ineffective when the input voltage is out of acceptable range.</li> </ul>

### 3-2. LCD Panel

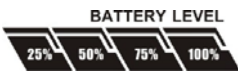

Display	Function
Remaining backup time information	
	Indicates the remaining backup time in pie chart.
	Indicates the remaining backup time in numbers. H: hours, M: minute, S: second
Fault information	
	Indicates that the warning and fault occurs.
	Indicates the warning and fault codes, and the codes are listed in details in 3-5 section.
Mute operation	
	Indicates that the UPS alarm is disabled.
Output & Battery voltage information	
	Indicates the output voltage, frequency or battery voltage. Vac: output voltage, Vdc: battery voltage, Hz: frequency
Load information	
	Indicates the load level by 0-25%, 26-50%, 51-75%, and 76-100%.
	Indicates overload.
	Indicates the load or the UPS output is short circuit.
Mode operation information	
	Indicates the UPS connects to the mains.
	Indicates the battery is working.
	Indicates the bypass circuit is working.
	Indicates the ECO mode is enabled.
	Indicates the Inverter circuit is working.
	Indicates the output is working.
Programmable outlets information	
	Indicates that programmable outlets have output voltage.
Battery information	

	Indicates the Battery level by 0-25%, 26-50%, 51-75%, and 76-100%.
	Indicates the battery is fault.
	Indicates low battery level and low battery voltage.
<b>Input &amp; Battery voltage information</b>	
	Indicates the input voltage or frequency or battery voltage. Vac: Input voltage, Vdc: battery voltage, Hz: input frequency

### 3-3. Audible Alarm

Battery Mode	Sounding every 4 seconds
Low Battery	Sounding every second
Overload	Sounding twice every second
Fault	Continuously sounding

### 3-4. LCD display wordings index

Abbreviation	Display content	Meaning
ENA	ENR	Enable
DIS	d IS	Disable
ESC	ESC	Escape
HLS	HLS	High loss
LLS	LLS	Low loss
BAT	bAt	Battery
CF	CF	Converter
TP	TP	Temperature
CH	CH	Charger
SF	SF	Site Fault
EP	EP	EPO
FU	FU	Bypass frequency unstable
EE	EE	EEPROM error

### 3-5. UPS Setting

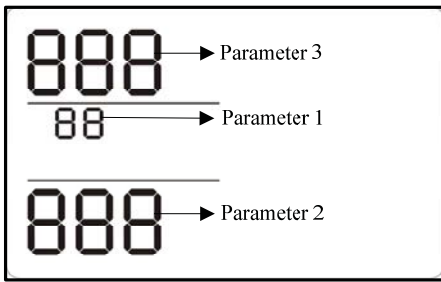

There are three parameters to set up the UPS.

Parameter 1: It's for program alternatives. Refer to below table.

Parameter 2 and parameter 3 are the setting options or values for each program.

#### ● 01: Output voltage setting

Interface	Setting
	<p>For 200/208/220/230/240 VAC models, you may choose the following output voltage:</p> <p>200: presents output voltage is 200Vac                  208: presents output voltage is 208Vac                  220: presents output voltage is 220Vac                  230: presents output voltage is 230Vac                  240: presents output voltage is 240Vac</p> <p>For 100/110/115/120VAC models, you may choose the following output voltage:</p> <p>100: presents output voltage is 100Vac                  110: presents output voltage is 110Vac                  115: presents output voltage is 115Vac                  120: presents output voltage is 120Vac</p>

#### ● 02: Frequency Converter enable/disable

Interface	Setting
	<p>CF ENA: converter mode enable                  CF DIS: converter mode disable(Default)</p>

#### ● 03: Output frequency setting

Interface	Setting
	<p>You may set the initial frequency on battery mode:</p> <p>BAT 50: presents output frequency is 50Hz                  BAT 60: presents output frequency is 60Hz</p> <p>If converter mode enable, you may choose the following output frequency:</p> <p>CF 50: presents output frequency is 50Hz                  CF 60: presents output frequency is 60Hz</p>



- 04: ECO enable/disable

Interface	Setting
	ENA: ECO mode enable DIS: ECO mode disable(Default)

- 05: AECO enable/disable

Interface	Setting
	ENA: Advanced ECO mode enable DIS: Advanced ECO mode disable(Default)

- 06: Bypass mode enable/disable when UPS is off

Interface	Setting
	ENA: Bypass mode is enabled when UPS is off DIS: Bypass mode is disabled when UPS is off (Default)

- 07: Programmable outlets enable/disable

Interface	Setting
	ENA: Programmable outlets enable DIS: Programmable outlets disable(Default)

- 08: Programmable outlets setting

Interface	Setting
	0-999: setting the backup time limits in minutes from 0-999 for programmable outlets which connect to non-critical devices on battery mode.

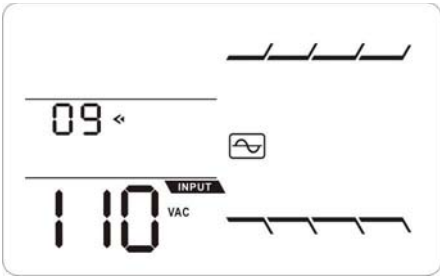

- 09: Acceptable input voltage range setting

Interface	Setting
	<p>For 200/208/220/230/240 VAC models, you may choose the following selection for acceptable input voltage range:</p> <p>110/300 flashing in turns: The acceptable input voltage range is from 110V to 300V.</p> <p>160/260 flashing in turns: The acceptable input voltage range is from 160V to 260V.</p> <p>170/270 flashing in turns: The acceptable input voltage range is from 170V to 270V.</p> <p>For 100/110/115/120 VAC models, you may choose the following selection for acceptable input voltage range:</p> <p>55/150 flashing in turns: The acceptable input voltage range is from 55V to 150V.</p> <p>80/130 flashing in turns: The acceptable input voltage range is from 80V to 130V.</p> <p>85/135 flashing in turns: The acceptable input voltage range is from 85V to 135V.</p>



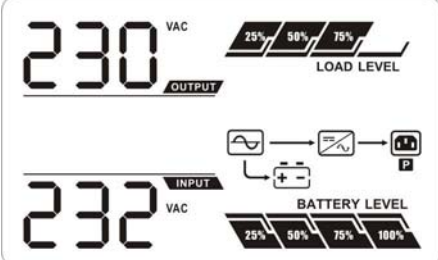
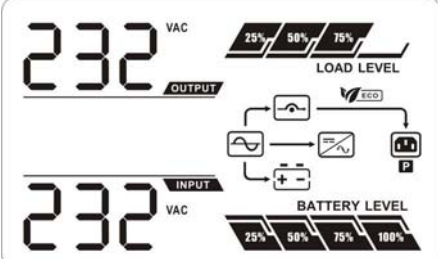
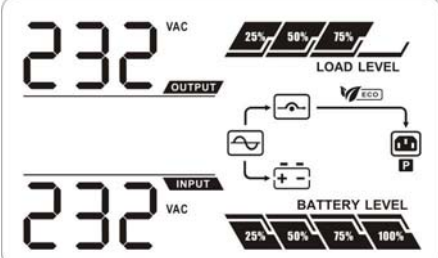
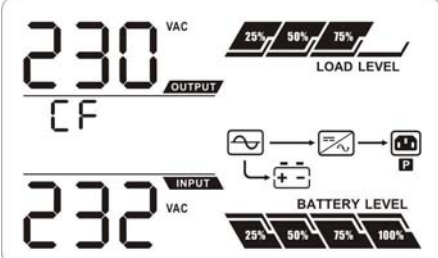
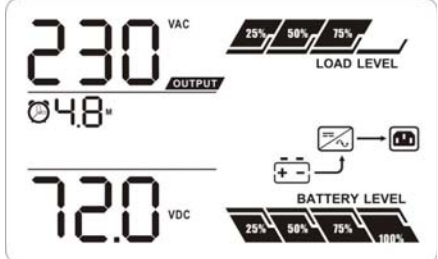
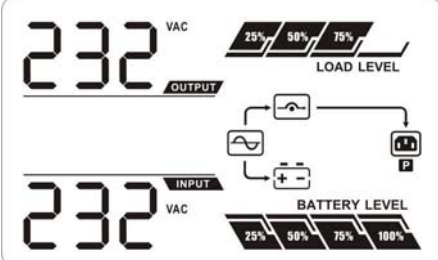

- 00: Exit setting

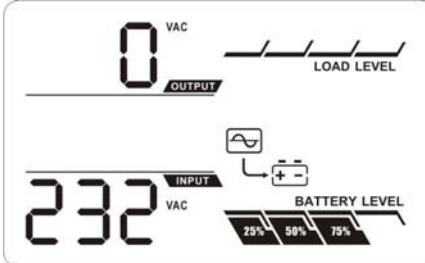
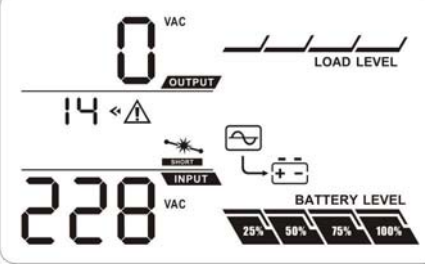
### 3-6. Operating Mode Description









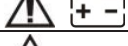

Operating mode	Description	LCD display
Online mode	When the input voltage is within acceptable range, UPS will provide pure and stable AC power to output. The UPS will also charge the battery at online mode.	 <p>The LCD display shows 230 VAC OUTPUT and 232 VAC INPUT. The BATTERY LEVEL indicator shows three bars (25%, 50%, 75%) and a battery icon with a plus sign. The LOAD LEVEL indicator shows three bars (25%, 50%, 75%) and a load icon.</p>
ECO mode (Efficiency Corrective Optimizer)	When the input voltage is within setting range ( $\pm 3\%V_o$ max), UPS will bypass voltage to output for energy saving. PFC and INVERTER are still active at this mode.	 <p>The LCD display shows 232 VAC OUTPUT and 232 VAC INPUT. The BATTERY LEVEL indicator shows four bars (25%, 50%, 75%, 100%) and a battery icon with a plus sign. The LOAD LEVEL indicator shows three bars (25%, 50%, 75%) and a load icon. An ECO mode icon is also present.</p>
AECO mode (Advanced Efficiency Corrective Optimizer)	When the input voltage is within setting range ( $\pm 3\%V_o$ max), UPS will bypass voltage to output for energy saving. PFC and INVERTER are off at this mode.	 <p>The LCD display shows 232 VAC OUTPUT and 232 VAC INPUT. The BATTERY LEVEL indicator shows four bars (25%, 50%, 75%, 100%) and a battery icon with a plus sign. The LOAD LEVEL indicator shows three bars (25%, 50%, 75%) and a load icon. An AECO mode icon is also present.</p>
Frequency Converter mode (Rack)	When input frequency is within 40 Hz to 70 Hz, the UPS can be set at a constant output frequency, 50 Hz or 60 Hz. The UPS will still charge battery under this mode.	 <p>The LCD display shows 230 VAC OUTPUT and 232 VAC INPUT. The BATTERY LEVEL indicator shows four bars (25%, 50%, 75%, 100%) and a battery icon with a plus sign. The LOAD LEVEL indicator shows three bars (25%, 50%, 75%) and a load icon. A CF icon is also present.</p>
Battery mode	When the input voltage is beyond the acceptable range or power failure and alarm is sounding every 4 second, UPS will backup power from battery.	 <p>The LCD display shows 230 VAC OUTPUT and 72.0 VDC. The BATTERY LEVEL indicator shows four bars (25%, 50%, 75%, 100%) and a battery icon with a plus sign. The LOAD LEVEL indicator shows three bars (25%, 50%, 75%) and a load icon. A 4.8 icon is also present.</p>
Bypass mode	When input voltage is within acceptable range but UPS is overload, UPS will enter bypass mode or bypass mode can be set by front panel. Alarm is sounding every 10 second.	 <p>The LCD display shows 232 VAC OUTPUT and 232 VAC INPUT. The BATTERY LEVEL indicator shows four bars (25%, 50%, 75%, 100%) and a battery icon with a plus sign. The LOAD LEVEL indicator shows three bars (25%, 50%, 75%) and a load icon.</p>

Standby mode	UPS is powered off without output power, but the battery still can be charged.	
Fault mode	The UPS is in fault mode when no output power is supplied from the UPS and the fault icon flashes on the LCD display, although the information of UPS can be displayed in the screen.	

### 3-7. Faults Reference Code



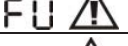





Fault event	Fault code	Icon	Fault event	Fault code	Icon
Bus start fail	01	x	Inverter voltage Low	13	X
Bus over	02	x	Inverter output short	14	
Bus under	03	x	Battery voltage too high	27	
Bus unbalance	04	x	Battery voltage too low	28	
Bus short circuited	05	x	Over temperature	41	X
Inverter soft start fail	11	x	Over load	43	
Inverter voltage high	12	x			



### 3-8. Warning indicator

Warning	Icon (flashing)	Alarm
Low Battery		Sounding every second
Overload		Sounding twice every second
Battery is not connected		Sounding every second
Over Charge		Sounding every second
Site Fault	SF 	Sounding every second
EPO enable	EP 	Sounding every second
Over temperature	ET 	Sounding every second
Charger failure	CH 	Sounding every second
Battery fault		Sounding every second
Out of bypass voltage range		Sounding every second
Bypass frequency unstable	FU 	Sounding every second
EEPROM error	EE 	Sounding every second

## 4. Troubleshooting

If the UPS system does not operate correctly, please solve the problem by using the table below.

Symptom	Possible cause	Remedy
No indication and alarm even though the main is normal.	The AC input power is not connected well.	Check if input power cord firmly connected to the mains.
	The AC input is connected to the UPS output.	Plug AC input power cord to AC input correctly.
The icon  is flashing and the warning code <b>EP</b> is lighting on LCD display. Alarm is sounding every second.	EPO function is activated.	Set the circuit in closed position to disable EPO function.
The icon  is flashing and <b>SF</b> is lighting on LCD display. Alarm is sounding every second.	Line and neutral conductors of UPS input are reversed.	Rotate mains power socket by 180° and then connect to UPS system.
The icon  and  flashing on LCD display and alarm is sounding every second.	The external or internal battery is incorrectly connected.	Check if all batteries are connected well.
Fault code is shown as 27 and the icon  is lighting on LCD display and alarm is continuously sounding.	Battery voltage is too high or the charger is fault.	Contact your dealer.
Fault code is shown as 28 and the icon  is lighting on LCD display and alarm is continuously sounding.	Battery voltage is too low or the charger is fault.	Contact your dealer.
The icon  and  is flashing on LCD display and alarm is sounding twice every second.	UPS is overload	Remove excess loads from UPS output.
	UPS is overloaded. Devices connected to the UPS are fed directly by the electrical network via the Bypass.	Remove excess loads from UPS output.
	After repetitive overloads, the UPS is locked in the Bypass mode. Connected devices are fed directly by the mains.	Remove excess loads from UPS output first. Then shut down the UPS and restart it.

<b>Symptom</b>	<b>Possible cause</b>	<b>Remedy</b>
Fault code is shown as 43 and The icon  is lighting on LCD display and alarm is continuously sounding.	The UPS shut down automatically because of overload at the UPS output.	Remove excess loads from UPS output and restart it.
Fault code is shown as 14 and the icon  is lighting on LCD display. Alarm is continuously sounding.	The UPS shut down automatically because short circuit occurs on the UPS output.	Check output wiring and if connected devices are in short circuit status.
Fault code is shown as 01, 02, 03, 04, 11, 12, 13 and 41 on LCD display and alarm is continuously sounding.	A UPS internal fault has occurred. There are two possible results: 1. The load is still supplied, but directly from AC power via bypass. 2. The load is no longer supplied by power.	Contact your dealer
Battery backup time is shorter than nominal value	Batteries are not fully charged	Charge the batteries for at least 5 hours and then check capacity. If the problem still persists, consult your dealer.
	Batteries defect	Contact your dealer to replace the battery.
Fault code is shown as 05 on LCD display. At the same time, alarm is continuously sounding and output is cut off.	A UPS internal fault has occurred and BUS is short circuited.	Consult your dealer. If the UPS power is on again before repair, the DC/DC mosfet will damage.

## 5. Storage and Maintenance

### 5-1. Operation

The UPS system contains no user-serviceable parts. If the battery service life (3~5 years at 25°C ambient temperature) has been exceeded, the batteries must be replaced. In this case, please contact your dealer.



Be sure to deliver the spent battery to a recycling facility or ship it to your dealer in the replacement battery packing material.

### Storage

Before storing, charge the UPS 5 hours. Store the UPS covered and upright in a cool, dry location. During storage, recharge the battery in accordance with the following table:

Storage Temperature	Recharge Frequency	Charging Duration
-25°C - 40°C	Every 3 months	1-2 hours
40°C - 45°C	Every 2 months	1-2 hours

## 6. Specifications

MODEL		DN-170040		DN-170041	
Capacity	VA/W	1500 VA / 1350 W		3000 VA / 2700 W	
<b>INPUT</b>					
Voltage Range	Low Line Transfer	80 VAC/70 VAC/60 VAC/55 VAC $\pm$ 5 % or 160 VAC/140 VAC/120 VAC/110 VAC $\pm$ 5 % (based on load percentage 100%-80% / 80%-70% / 70%-60% / 60%-0)			
	Low Line Comeback	85 VAC/75 VAC/65 VAC/60 VAC $\pm$ 5 % or 170 VAC / 150 VAC / 130 VAC / 120 VAC $\pm$ 5 %			
	High Line Transfer	150 VAC $\pm$ 5 % or 300 VAC $\pm$ 5 %			
	High Line Comeback	140 VAC $\pm$ 5 % or 290 VAC $\pm$ 5 %			
Frequency Range		40Hz ~ 70Hz			
Power Factor		$\geq$ 0.99 @normal voltage			
<b>OUTPUT</b>					
Output Voltage		100*/110*/115*/120/127 VAC or 200/208/220/230/240 VAC			
AC Voltage Regulation		$\pm$ 1%			
Frequency Range		47 ~ 53 Hz or 57 ~ 63 Hz (Synchronized Range)			
Frequency Range		50Hz $\pm$ 0.5% or 60Hz $\pm$ 0.5% (Bat. Mode)			
Current Crest Ratio (CF)		5:1 (max.)			
Harmonic Distortion (THDU)		$\leq$ 2% THD (Linear load) $\leq$ 4% THD (Non-linear load)			
Transfer Time	AC to DC	Zero			
	Inverter to Bypass	4 ms (Typical)			
Waveform (Batt. Mode)		Pure Sinewave			
<b>EFFICIENCY</b>					
AC Mode		88%		89%	
Battery Mode		86%		87%	
ECO Mode		95%		97%	
<b>BATTERY</b>					
Battery Type	12V/9Ah	Depending on application	12V/9Ah	Depending on application	
Numbers	3		6		
Typical Recharge Time		4 hours recover to 90% capacity (for standard model only)			
Charging Current (max.)		1 A	1A/2A/4A/8A	1 A	1A/2A/4A/8A
Charging Voltage		41.1 VDC $\pm$ 1%		82.1VDC $\pm$ 1%	
<b>INDICATORS</b>					
LCD	UPS status, Load level, Battery level, Input/Output/battery info, Discharge time and Fault indicators				
<b>ALARM</b>					
Battery Mode	Sounding every 4 seconds				
Low Battery	Sounding every second				
Overload	Sounding twice every second				
Fault	Continuously sounding				
<b>PHYSICAL</b>					
Dimension, DxWxH (mm)		510 x 438 x 88		630 x 438 x 88	
Net Weight (kgs)		17.6	10.7	28	13.8
<b>ENVIRONMENT</b>					
Humidity		20-90 % RH @ 0- 40°C (non-condensing)			
Noise Level		Less than 50dBA @ 1 Meter			
<b>MANAGEMENT</b>					
Smart RS-232/USB		Supports Windows 2000/2003/XP/Vista/2008/7, Linux, Unix, and MAC			
Optional SNMP		Power management from SNMP manager and web browser			

\*Derate capacity to 95% when the output voltage is adjusted to 115VAC. Derate capacity to 90% when the output voltage is adjusted to 110VAC and derate capacity to 80% when the output voltage is adjusted to 100VAC/200VAC/208VAC.